

# APOLLO 1U ICE

19" 1U Rack Mount  
Industrial Compact Enclosure  
Technical Manual





## Contents

About this manual .....	4
Related documents .....	4
Conventions .....	4
Introduction .....	5
APOLLO ICE specification .....	6
Using the enclosure safely .....	8
APOLLO 1U ICE 'at a glance' .....	9
Features of the APOLLO ICE .....	10
Fan control .....	11
Connectors .....	12
Internal configuration .....	20
Internal cable plan .....	21
PCI Card Module .....	22
Tamper detect switch .....	24
User status/display and navigation buttons .....	25
Front panel breakout module .....	27
Drive Bay Module .....	29
Dimension details .....	30
Weight details .....	31
Appendix A – Contacting Eurotech .....	32
Appendix B - Optional ADD (AGP Digital Display) graphics cards .....	33
APOLLO-USB-DVO: TV .....	33
APOLLO-USB-DVO: VGA .....	34
Appendix C – EMC conformity .....	35
Index .....	36



# About this manual

## Related documents

You can find further detailed information about the performance and operation of the APOLLO SBC in the APOLLO Technical Manual.

## Conventions

The following symbols are used in this guide:

Symbol	Explanation
	Note - information that requires your attention.
	Tip - a handy hint that may provide a useful alternative or save time.
	Caution – proceeding with a course of action may damage your equipment or result in loss of data.

## Introduction

The APOLLO 1U ICE system serves as a high performance, compact 19" rack mount ruggedized PC system for applications in IT systems, machine control, and kiosk solutions. The APOLLO 1U ICE is powered by a Celeron M/Pentium M based single board computer designed and manufactured by Eurotech Ltd. The motherboard and system components are designed for long life support with scalable CPU options from the 600MHz Celeron M for quiet PCs with a wide operating temperature, up to powerful server grade systems fitted with the 2.1GHz Pentium M CPU.

This ruggedized system has a full compliment of PC features including dual Ethernet (with optional Gigabit Ethernet), USB ports, dual Firewire, CompactFlash port, serial ports and a number of additional features for creating secure systems. The system can also be fitted with 2 PCI add-on cards.

The system is available with options for multiple video outputs, integrated wireless modules (with a location for external antenna) and complete operation from solid-state CompactFlash storage cards.

The front panel LCD display and navigation buttons can be used for user-defined configuration and control for deeply 'embedded systems' which do not have access to a display. For applications in secure locations, the APOLLO ICE includes an integrated tamper detection switch to monitor and record access to the system. Please refer to the APOLLO Technical Manual for detailed information about the performance and operation of the APOLLO SBC.

## APOLLO ICE specification

The APOLLO ICE includes the following standard features:

- 1U 19" standard 'ruggedized' enclosure.
- Pentium M/Celeron M processor performance options.
- Down to 600MHz Celeron M for fan-less systems.
- Up to 2.1GHz Pentium M for server performance.
- 1.6GHz Pentium M and low profile fan fitted as standard.
- Up to 1GB system DRAM.
- Dual independent video (CRT & LVDS; LVDS requires a separate cable assembly).
- Options for CRT, DVI, S-video and Composite video (NTSC or PAL) modules are available on request. Contact Eurotech Ltd's sales team for details (see page [32](#)).
- Two 10/100baseT Ethernet ports (with 1000baseT option).
- CF+ CompactFlash port for Type II cards (Flash cards, Micro-drives, Wi-Fi, Bluetooth etc).
- Two serial ports, parallel port, IrDA port.
- Four USB 2.0 compliant ports.
- Two IEEE1394a-2000 compliant (Firewire) ports.
- 6 channel surround sound audio with SPDIF ports.
- Front panel 2 line 24 character LCD display and navigation buttons.
- Front panel access to two USB and one Firewire port.
- Auto-ranging 90-265V, 47-63Hz AC, 180W Flex-ATX PSU.
- DC power input option also available on request. Contact Eurotech Ltd's sales team for details (see page [32](#)).
- Two PCI (rev 2.2) expansion slots via an internal flexible riser.
- Internal DVD/CDRW. Speeds: 24x CD-R writing, 16x CD-RW writing, 24x CD-ROM reading, 8x DVD-ROM reading.
- Standard floppy disk drive.
- Internal high shock resistant 2.5" hard disk drive (40GB minimum) – optional 3½" hard disk drive also available.
- Operating temperature: +5°C to +55°C (41°F to 131°F)<sup>1</sup>.
- EMC conformity: CE/FCC compliant (see page 35).
- Safety compliance: UL, cUL, CB (power supply).

---

<sup>1</sup> The temperature specification may be extended with other build options. The widest operating temperature specification is -20°C to +65°C (-4°F to 149°F).

Factory build options available include:

- Other CPU options with/without CPU fan available on request. Please contact our Sales team for price and availability - see Appendix A – Contacting Eurotech on page 32.
- APOLLO motherboard fitted with Gigabit Ethernet option (providing 1x 10/100baseT and 1x 1000baseT ports).
- APOLLO motherboard fitted with Trusted Platform Module (TPM).
- APOLLO motherboard fitted with extra CRT video output.
- APOLLO motherboard fitted with composite (S-video) output.
- System without HDD – using solid state CompactFlash only.

## Using the enclosure safely

### *Internal battery*

The APOLLO SBC is fitted with a 3V Lithium battery that is used to maintain the APOLLO's real time clock and static RAM while the main supply is removed. The battery is fitted in a socket to allow easy replacement. The battery has a service life of 5 years at +25°C (77°F).

### *Anti-static handling*

The APOLLO and other circuit boards fitted inside the APOLLO 1U ICE contain CMOS devices. These could be damaged in the event of static electricity being discharged through them. At all times, please observe anti-static precautions when handling circuit boards. This includes storing boards in appropriate anti-static packaging and wearing a suitably earthed wrist strap when handling.

### *Packaging*

If the system is returned to Eurotech Ltd, it should be adequately packed, preferably in the original packing material. Damage caused in transit may invalidate any warranty claim.

### *Safe battery use*



Lithium batteries that are found to be damaged, leaking, corroded or flat (low or no voltage) must be disposed of in a safe manner following the relevant COSHH regulations.

Damaged, leaking, or corroded batteries (especially lithium batteries) must only be handled with caution. Use non-conductive tools and wear suitable protection, e.g. safety glasses, rubber gloves, etc.

All faulty batteries must be segregated in a suitable, clearly marked non-conductive container. They must be periodically disposed of by a recognized company specializing in the disposal of poisonous waste, who comply with 'The Disposal of Poisonous Waste Regulations Act.'

Replace with the same or equivalent type recommended by the manufacturer.

Dispose of batteries according to the manufacturer's instructions.

Do not attempt to recharge, disassemble, heat above 100°C (212°F), or incinerate the Lithium battery.

---



# APOLLO 1U ICE 'at a glance'

## Front panel view

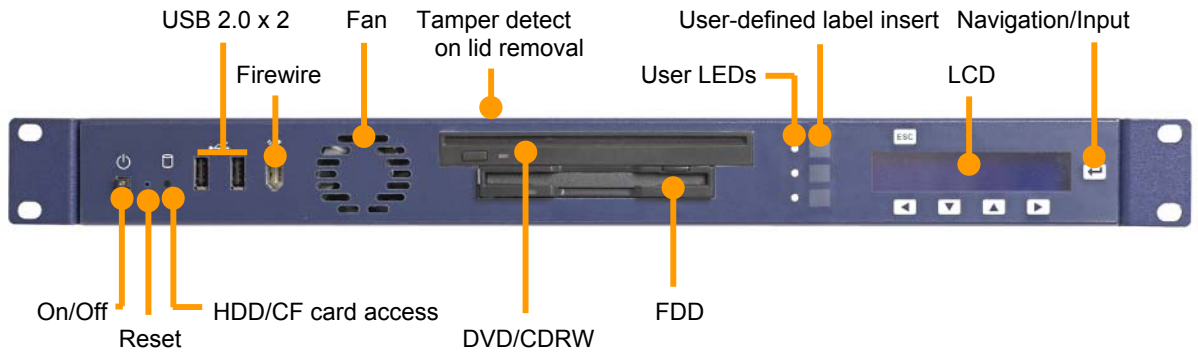

## Rear panel views

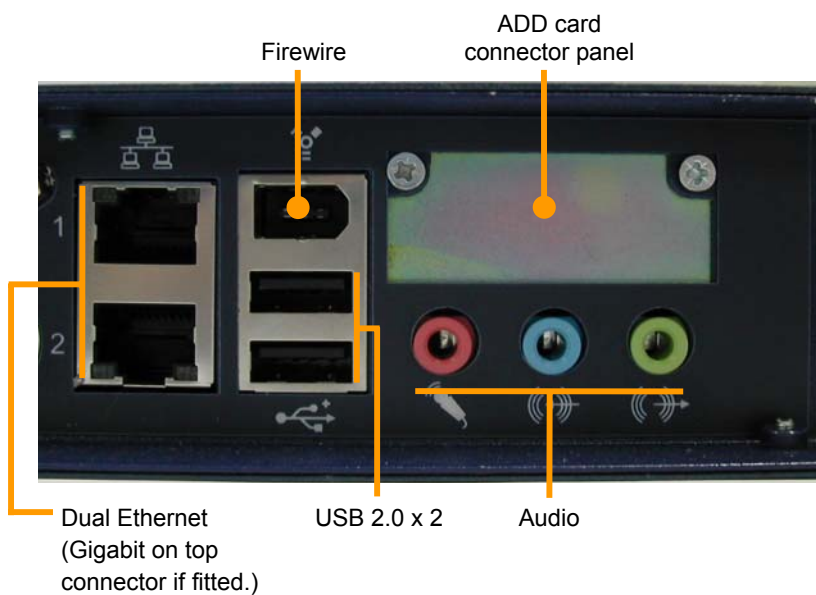
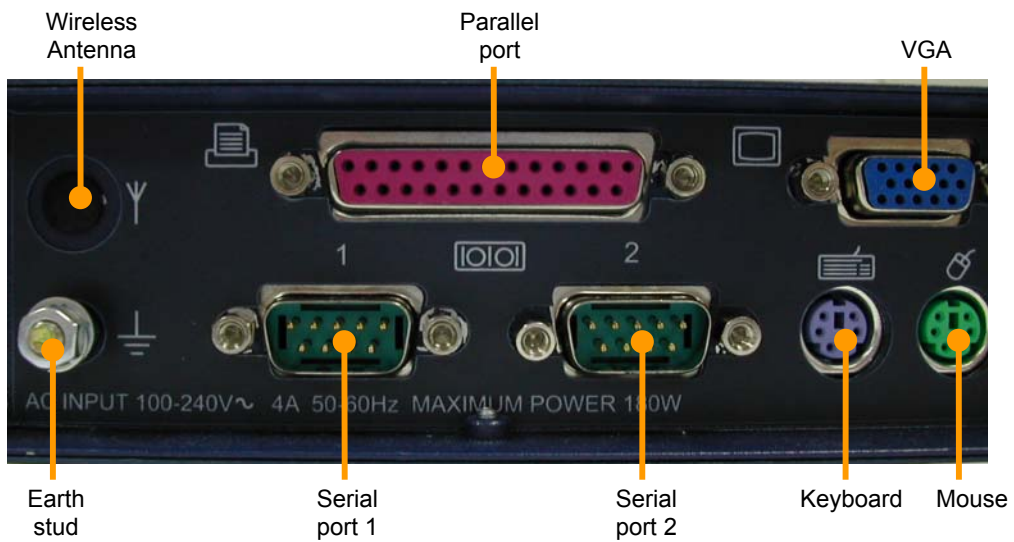

## Features of the APOLLO ICE

This 1U high 19" Rack Mount enclosure offers the following features:

### *Front panel*

- On/Off momentary switch with integral power LED (blue).
- Access hole to recessed reset switch.
- HDD activity indicator.
- 2 x USB 2.0 channels.
- 1 x Firewire (IEEE 1394a-2000) port.
- System fan (air flows into the APOLLO ICE).
- Slot-loading DVD/CDRW drive.
- Slimline FDD drive.
- User-defined 'identification' label and status LEDs.
- LCD character display – 2 rows x 24 characters.
- User navigation and input switches.

### *Rear panel*

- AC input (IEC connector) and PSU fan.
- Aperture for wireless antenna (SMA) connector.
- Earth stud.
- 1 x Parallel port.
- 2 x Serial ports.
- 1 x VGA connector.
- 1 x PS/2 MiniDIN mouse connector.
- 1 x PS/2 MiniDIN keyboard connector.
- 2 x 10/100 Ethernet ports (optional 1000baseT Gigabit Ethernet).
- 1 x Firewire port.
- 2 x USB 2.0 channels.
- 3 x Stereo audio jacks.
- ADD card connector panel.
- 2 x PCI card breakout positions.

### *Additional features*

The APOLLO ICE also has an internal 40GB (minimum) Hard Disk Drive.

## Fan control

There are two fans on the APOLLO 1U ICE that can be controlled - the processor/CPU fan, and the system fan. (The fan in the PSU runs at a predetermined speed.)

You can independently control the fan speed and preset using the BIOS screens. To do this, follow these steps:

- 1 Press **F2** during boot up and enter the BIOS setup facility.
- 2 Use the right arrow key to choose the **Advanced** menu.
- 3 Use the down arrow key to highlight **Hardware Monitor**, and then press **Enter**.
- 4 Ensure **Fan Speed Control** is highlighted, and then press **Enter**.
- 5 Highlight the fan you wish to set, and press **Enter**.
- 6 Change the fan speed to the desired percentage of its maximum capacity and press **Enter**.
- 7 Exit from the BIOS screens, saving your changes.

## Connectors

The connectors on the APOLLO let you connect external devices such as keyboards, mouse devices, printers etc.

Connector	Function	See ...
J1	Audio Line Out.	Page <a href="#">13</a> .
J2	Audio Line In.	Page <a href="#">13</a> .
J3	Audio Mic In.	Page <a href="#">14</a> .
J4A	IEEE1394 port 0.	Page <a href="#">14</a> .
J4B, J4C	USB ports 1 to 2.	Page <a href="#">14</a> .
J5A	Primary LAN.	Page <a href="#">15</a> .
J5B	Secondary LAN.	Page <a href="#">15</a> .
J6A	VGA connector.	Page <a href="#">16</a> .
J6B	Keyboard.	Page <a href="#">16</a> .
J6C	Mouse.	Page <a href="#">17</a> .
J7A	Parallel port (LPT1).	Page <a href="#">18</a> .
J7B, J7C	Serial ports 1 to 2.	Page <a href="#">19</a> .

The connectors are illustrated in the following diagram.

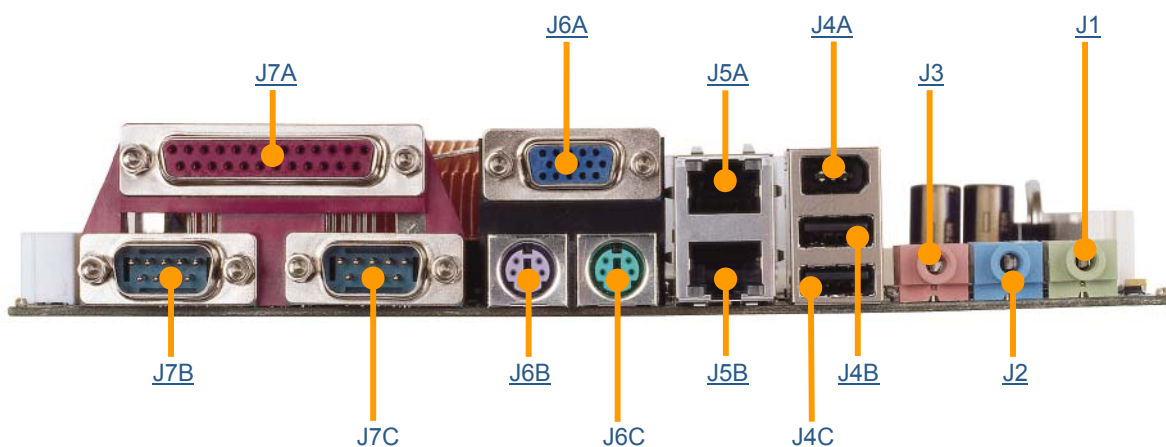

Further details about these connectors are provided in the following sections.

*J1, J2, J3 – Audio connectors*

3.5mm stereo audio jacks are used for audio connection. The audio codec can operate in either of the following modes:

- 2.1 mode, which allows for microphone in, line in and line out operation.
- 5.1 mode, which provides six-channel surround sound output. The microphone input and line in are not available during six channel mode.

Selection of 2.1 or 5.1 mode is made using software.

The audio connectors are illustrated in the following diagram:

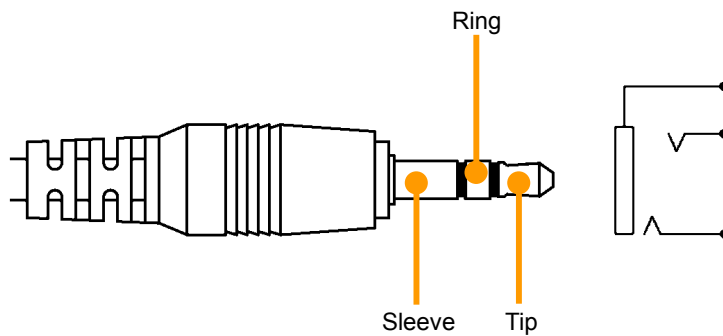

The pin settings for each connector are described in the following sections:

*J1 - 3.5mm audio jack*

PC99 Color: lime.

Pin	Signal name	
	2.1 mode	5.1 mode
Tip	Line out left	Surround out left
Ring	Line out right	Surround out right
Sleeve	Ground	Ground

*J2 - 3.5mm audio jack*

PC99 Color: light blue.

Pin	Signal name	
	2.1 mode	5.1 mode
Tip	Line in left	Rear surround left
Ring	Line in right	Rear surround right
Sleeve	Ground	Ground

*J3 - 3.5mm audio jack*

PC99 Color: pink.

Pin	Signal name	
	2.1 mode	5.1 mode
Tip	Microphone In	Surround centre
Ring	No Connect	Low frequency effects
Sleeve	Ground	Ground

*J4A – IEEE1394 connector port 0*

6-pin IEEE1394 connector.

Pin	Signal name
1	+12V (Fused)
2	Ground
3	TPB0-
4	TPB0+
5	TPA0-
6	TPA0+

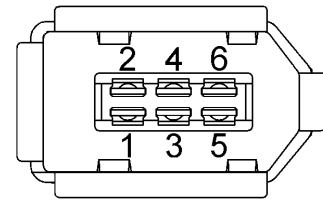

*J4B and J4C – USB ports 1 and 2*

USB type A connector.

Pin	Signal name
1	VBUS
2	Data-
3	Data+
4	Ground

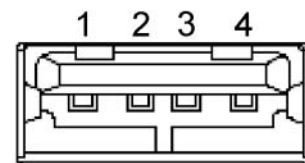

**J5A – Primary LAN**

RJ-45 10/100Mb/s or optional 10/100/1000Mb/s.

Pin	Signal name (10/100)	Signal name (10/100/1000)
1	TX+	MD0+
2	TX-	MD0-
3	RX+	MD1+
4	No Connect	MD2+
5	No Connect	MD2-
6	RX-	MD1-
7	No Connect	MD3+
8	No Connect	MD3-

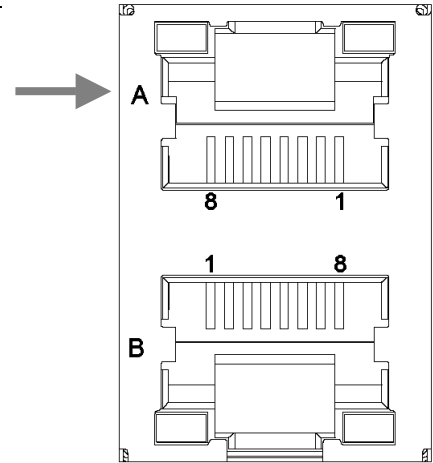

For a Gigabit Ethernet (10/100/1000) connection the network cable should be a CAT5 or above and include all four pairs.

**J5B – Secondary LAN**

RJ-45 10/100Mb/s.

Pin	Signal name
1	TX+
2	TX-
3	RX+
4	No Connect
5	No Connect
6	RX-
7	No Connect
8	No Connect

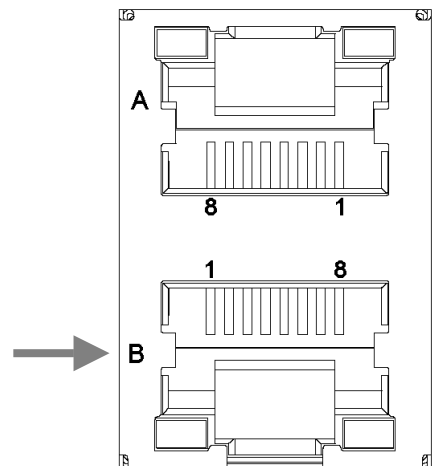

*J6A – VGA CRT connector*

DB15 Female

PC99 Color: Blue

Pin	Signal name	Pin	Signal name
1	Red	2	Green
3	Blue	4	No Connect
5	Ground	6	Ground
7	Ground	8	Ground
9	+5V (Fused)	10	Ground
11	No Connect	12	DDCSDA
13	HSYNC	14	VSYNC
15	DDCSCL		

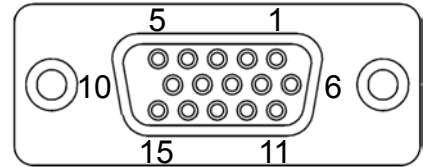

*J6B – PS/2 keyboard*

Connector: 6-pin Mini-DIN

PC99 Color: Purple

Pin	Signal name
1	KB DATA
2	No Connect
3	Ground
4	+5V
5	KB CLOCK
6	No Connect

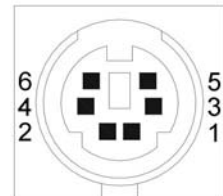



*J6C – PS/2 mouse*

Connector: 6-pin Mini-DIN.

PC99 Color: Green

Pin	Signal name
1	MS DATA
2	No Connect
3	Ground
4	+5V
5	MS CLOCK
6	No Connect

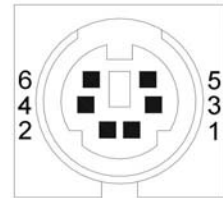

*J7A – Parallel port (LPT1)*

DB25 female

PC99 Color: Maroon

DB25 D-type socket	Signal name
1	STROBE
2	D0
3	D1
4	D2
5	D3
6	D4
7	D5
8	D6
9	D7
10	ACKNOWLEDGE
11	BUSY
12	PAPER EMPTY
13	SELECT
14	AUTOFEED
15	ERROR
16	INIT
17	SELECT IN
18	Ground
19	Ground
20	Ground
21	Ground
22	Ground
23	Ground
24	Ground
25	Ground

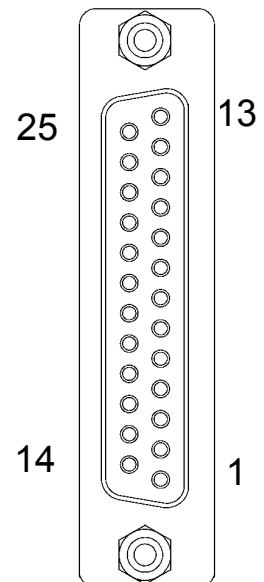

*J7B and J7C – COM1 and COM2 RS232 serial ports*

DB9 male

PC99 Color: Aqua

Pin	Signal name	Pin	Signal name
1	Data Carrier Detect (DCD)	2	Receive Data (RX)
3	Transmit Data (TX)	4	Data Terminal Ready (DTR)
5	Ground	6	Data Set ready (DSR)
7	Request To Send (RTS)	8	Clear To Send (CTS)
9	Ring Indicator (RI)		

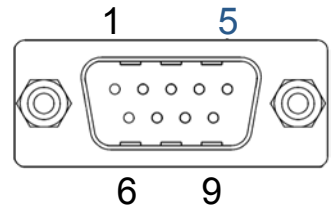

# Internal configuration



Refer to [Using the enclosure safely](#) on page 8 before proceeding any further.

The internal components of the unit must only be accessed by suitably qualified personnel using anti-static equipment. The power supply must be switched off and the AC input cable unplugged.

The following diagram illustrates the construction of the APOLLO ICE.

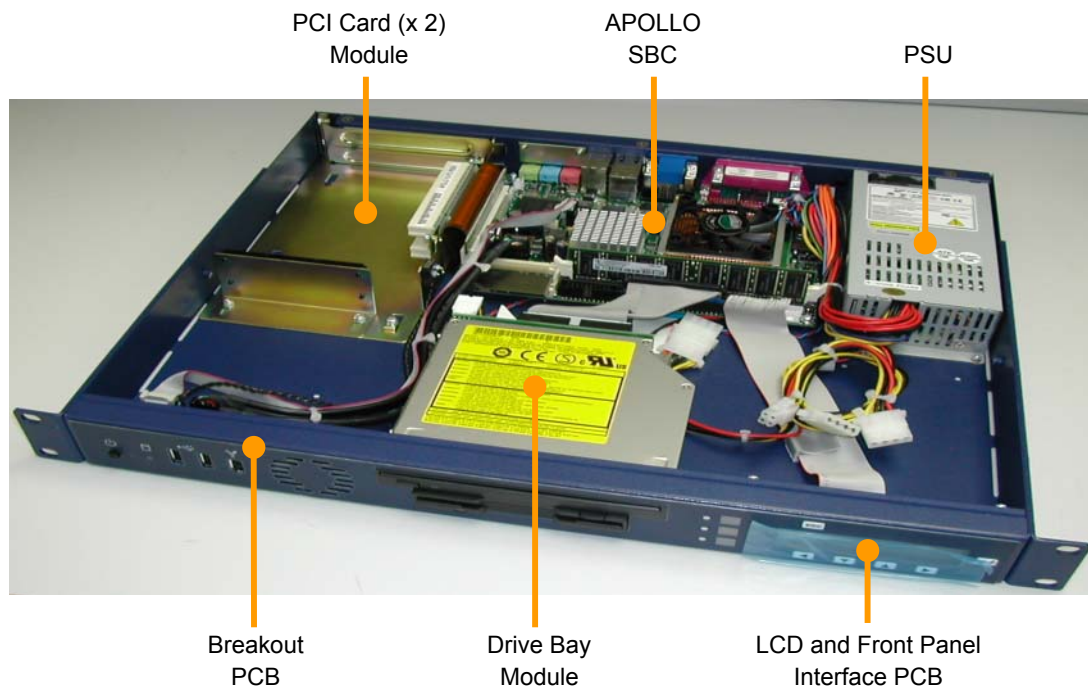

The following sections describe features of the highlighted areas above.

### Internal cable plan

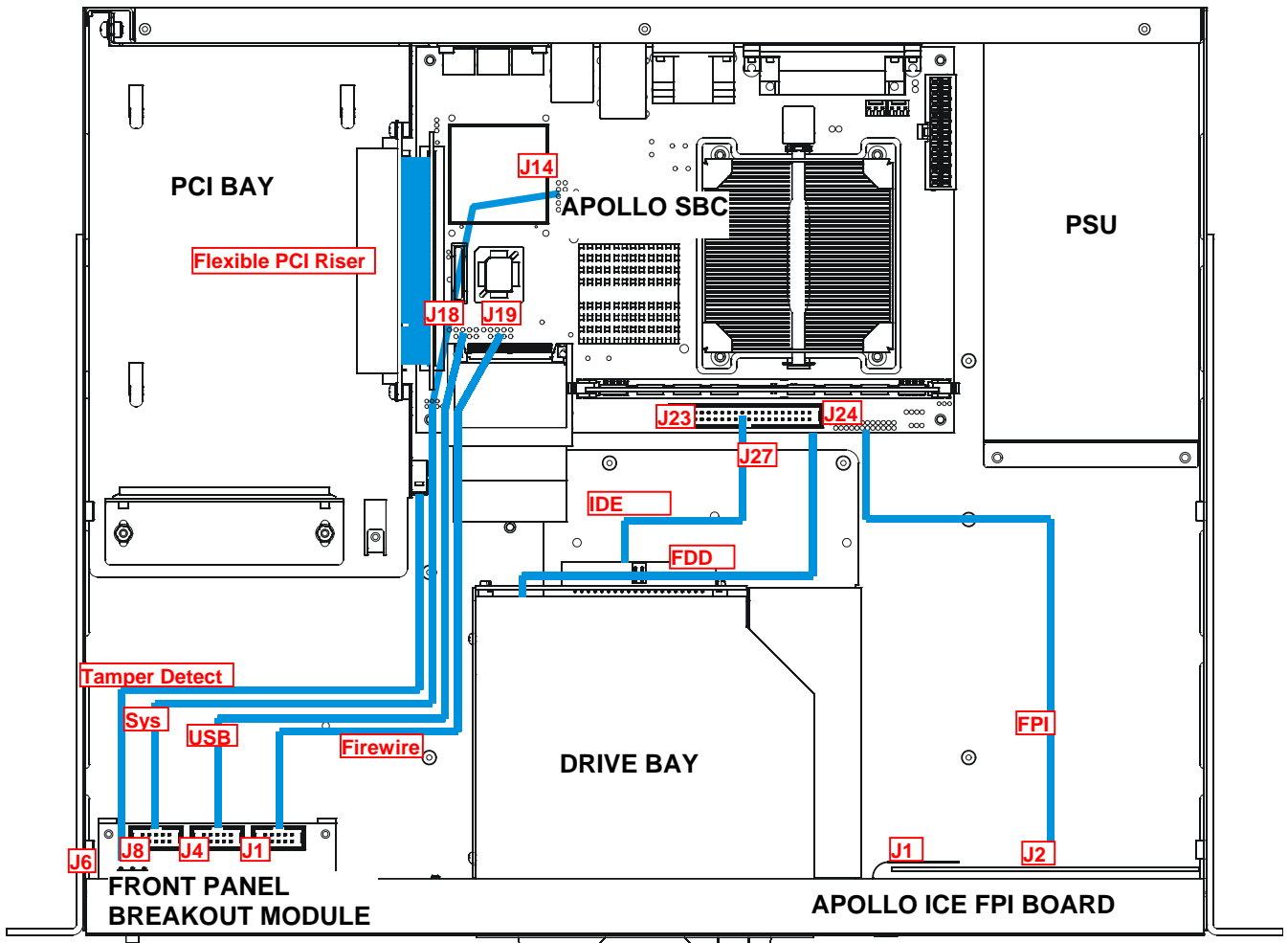

For clarity, power cables are not shown.

## PCI Card Module

This section explains how to remove the PCI Module and fit a PCI card. The components described in the procedures that follow are illustrated by the following diagram:

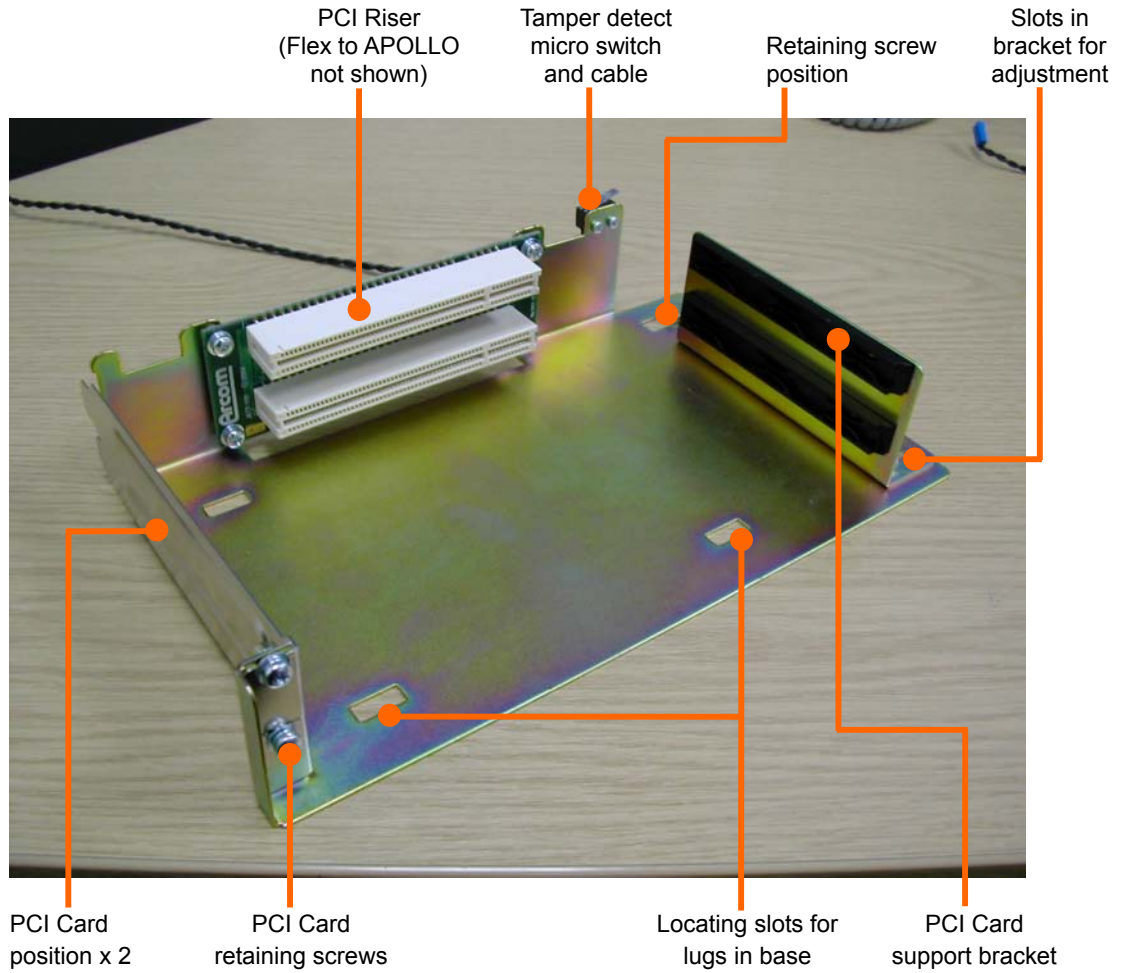

Remove any cables attached to installed PCI expansion cards before attempting removal of the PCI module.

To remove the PCI Module, follow these steps:

- 1 Unplug the flexible riser connection to the APOLLO SBC.
- 



Take care to pull on the plug-in connector rather than the flexible cable.

---

- 2 Disconnect the tamper detect cable from front panel breakout board assembly.

The PCI module is retained in the enclosure by formed lugs on the base, and one retaining screw.

- 3 Unscrew the retainer and slide the PCI Module back to clear the lugs on the base, and lift out.
- 



Be careful of the tamper detect switch and cable when the PCI module is removed.

---

To fit a PCI card:

- 1 Remove the blanking plate.
- 2 Plug the card into the riser.
- 3 Adjust and fix the support bracket to suit.
- 4 Tighten the retaining screw.

To install the PCI Module, reverse the procedure outlined above.

## Tamper detect switch

The tamper detect feature is triggered by the opening and closing of the lid. It is affected by a switch mounted on the PCI module:

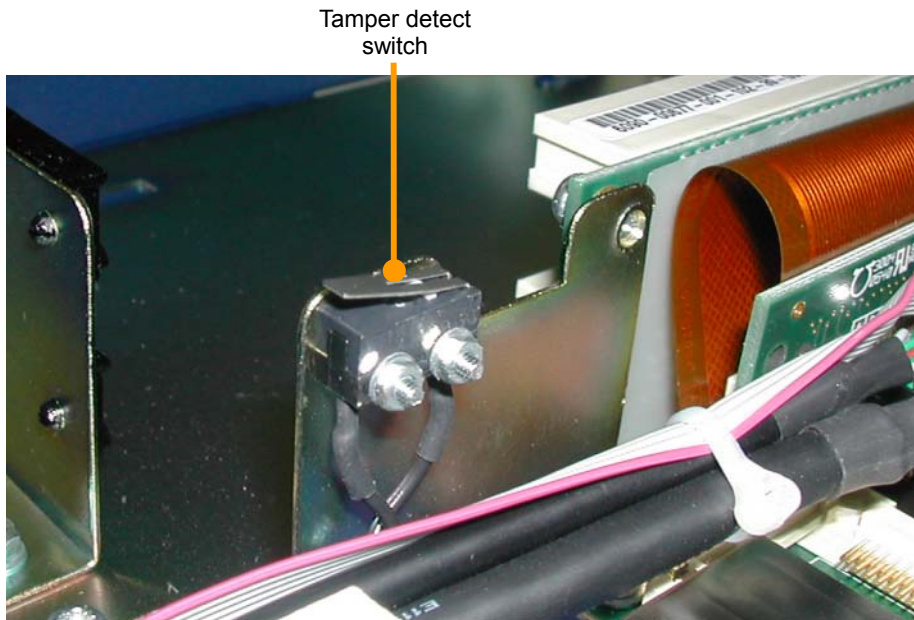

A tamper detection input is included within the real time clock circuitry of the APOLLO that operates in all power modes. The status of the tamper detection bit is battery backed in static RAM. Using a normally open switch, a tamper is detected when the switch contacts close.

The BIOS security setup screen provides two options for enabling a case open warning. It also provides a secure chassis mode that requires the supervisor password to be entered and the chassis intrusion detection to be disabled before the board will boot to an operating system. Both options are disabled by default; refer to the APOLLO Technical Manual for details.



## User status/display and navigation buttons

The LCD offers 2 x 24 character visibility with white lettering on an illuminated blue background. The Front Panel Interface enables connection to the front navigation/input switches and the three user-defined LEDs.

The LCD and Front Panel Interface are shown in the following photograph:



LED ident strip

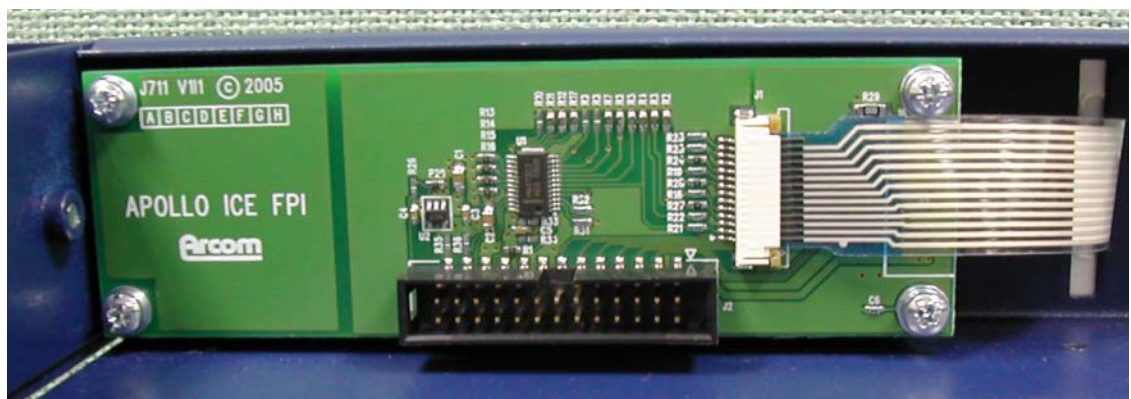

The Front Panel Interface is 'stacked' on the back of the LCD and has the tail from the front membrane plugged into a ZIF socket.

The following images illustrate how you insert the LED ident strip:



The LED ident strip can be reversed for writing legends, or discarded and a printed card inserted in the open slot.

Control of the character display, LEDs and navigation keys is implemented using drivers supplied by Eurotech Ltd. These functions are fully programmable and are available as user-defined controls for OEM customers. Drivers are available for Windows XP and Linux. Contact Eurotech Ltd Technical Support for further information (see page [32](#)).

## Front panel breakout module

Eurotech Ltd ref. 6060-0709-001-102.

The front panel breakout module assembly is shown in the following photograph:

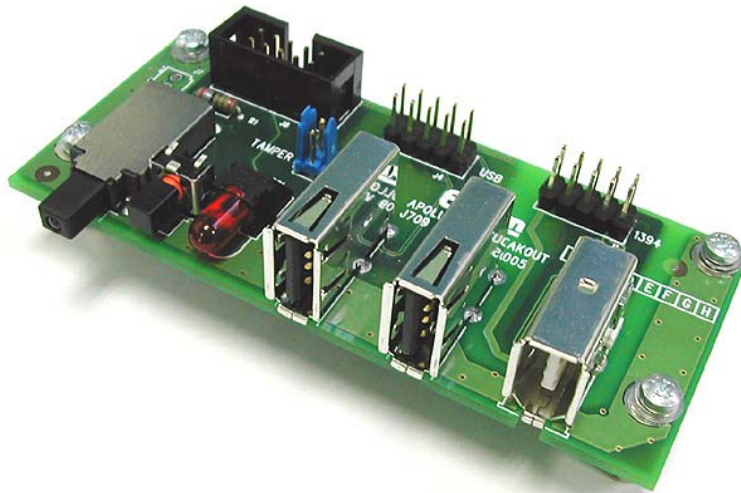

### Features

- On/off momentary switch with integral blue LED.
- Reset switch.
- HDD/CF card activity indicator LED.
- USB 2.0 ports (x2).
- Firewire IEEE1394 port.

*Pin settings*

The following pin settings are as viewed looking at the front panel:

*USB 2.0*

Pin	Signal
1	VBUS
2	Data-
3	Data+
4	Ground

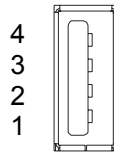

*Firewire*

Pin	Signal
1	+12V
2	Ground
3	TPB0-
4	TPB0+
5	TPA0-
6	TPA0+

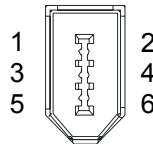

## Drive Bay Module

The drive bay module features:

- Slimline slot loading DVD/CDRW (Primary Slave).
- 1.44MB floppy disk drive.
- Slimline 40GB 2.5" hard disk drive (Master).
- CD/DVD adapter pcb.

It is shown in the following photographs:



CD/DVD adapter pcb

To remove the drive bay module, follow these steps:

- 1 Unplug the FDD flat flexible connection to the APOLLO SBC, the IDE connection cable and all power cables.
- 2 Undo the four countersunk screws through the base that retain the Drive Bay Module in the enclosure.
- 3 Withdraw the whole assembly from the unit.

To install the module, reverse the above procedure.

### Dimension details

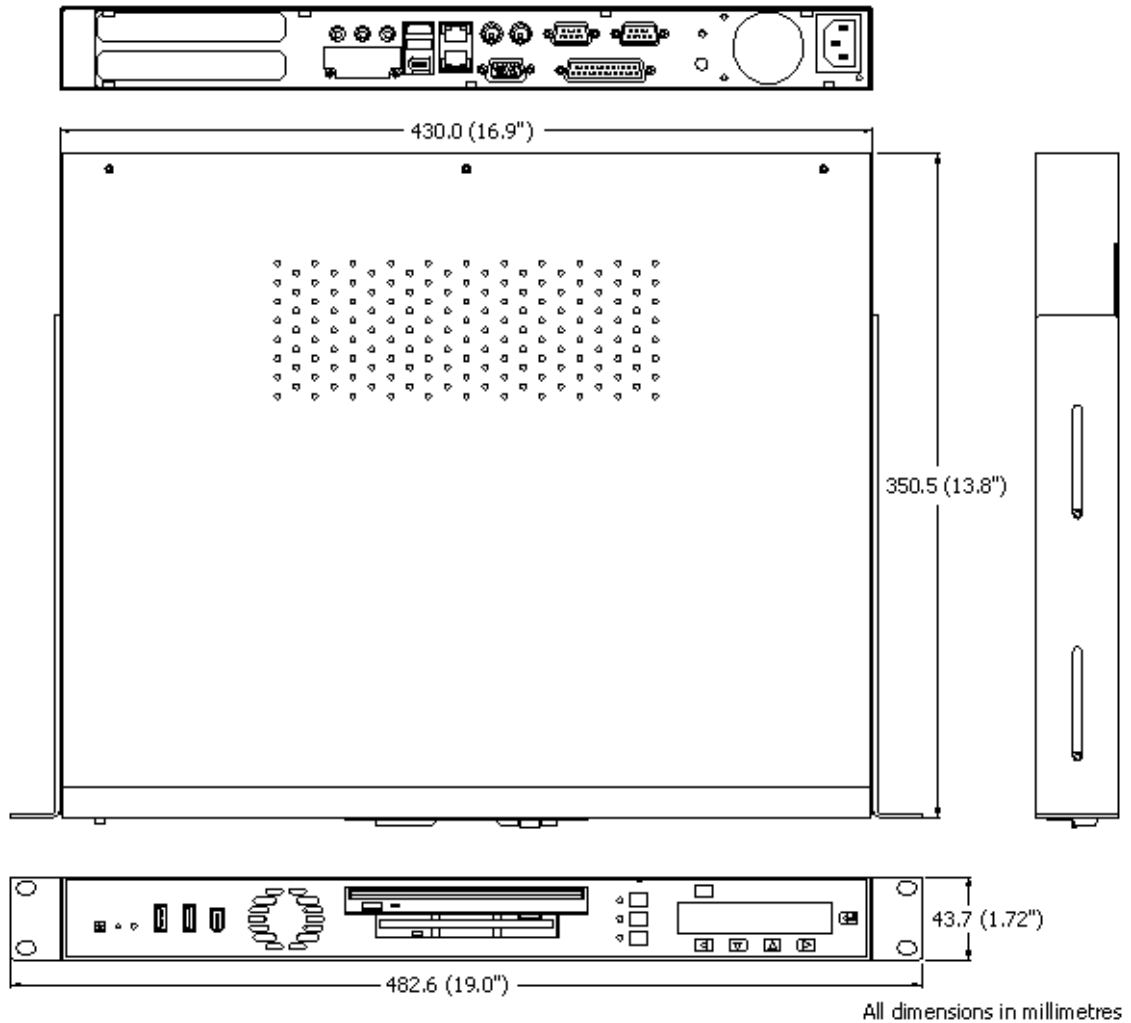

All dimensions in millimetres

The unit complies with standard (IEC 60297 and IEC 60917) 19" Rack Mounting dimensions and will fit into a standard rack cabinet.



The rack mount brackets can be adjusted in order to recess front panel features (i.e. to ensure connectors clear cabinet doors etc.).

## Weight details

The weight of the unit depends on the configuration used and the optional items chosen when ordering, the unit nominal weight is approximately 6.0kg (13.20lbs).

## Appendix A – Contacting Eurotech

### Eurotech sales

Eurotech's sales team is always available to assist you in choosing the board that best meets your requirements.

Eurotech Ltd  
3 Clifton Court  
Cambridge  
CB1 7BN  
UK

Tel: +44 (0)1223 403410

Fax: +44 (0)1223 410457

Email: [sales@eurotech-ltd.co.uk](mailto:sales@eurotech-ltd.co.uk)

Comprehensive information about our products is also available at our web site:

[www.eurotech-ltd.co.uk](http://www.eurotech-ltd.co.uk).



While Eurotech's sales team can assist you in making your decision, the final choice of boards or systems is solely and wholly the responsibility of the buyer. Eurotech's entire liability in respect of the boards or systems is as set out in Eurotech's standard terms and conditions of sale. If you intend to write your own low level software, you can start with the source code on the disk supplied. This is example code only to illustrate use on Eurotech's products. It has not been commercially tested. No warranty is made in respect of this code and Eurotech shall incur no liability whatsoever or howsoever arising from any use made of the code.

---

### Eurotech technical support

Eurotech has a team of dedicated technical support engineers available to provide a quick response to your technical queries.

Tel: +44 (0)1223 412428

Fax: +44 (0)1223 410457

Email: [support@eurotech-ltd.co.uk](mailto:support@eurotech-ltd.co.uk)

### Eurotech Group

Eurotech Ltd is a subsidiary of Eurotech Group. For further details see

[www.eurotech.com](http://www.eurotech.com)



## Appendix B - Optional ADD (AGP Digital Display) graphics cards

The APOLLO can drive the Digital Video Output (DVO) port of the Intel Extreme 2 Graphics Controller to connector J16. This provides a means for adding an extra graphics port to the APOLLO. Eurotech Ltd provides ADD modules to support either TV output or VGA output (for further details, see below). For information about DVI or LVDS ADD cards for the APOLLO, please contact Eurotech Ltd Sales (see the previous page).

### APOLLO-USB-DVO: TV



The TV Card converts APOLLO high-resolution DVO (Digital Video Output) from VGA to SXGA resolutions, and produces standard analog television (SDTV) output to S-Video and composite video connector outputs. The following image shows the TV card in position:



#### Features

- NTSC and PAL.
- S-Video Output (Mini-DIN4).
- Composite Video Output (RCA Jack).
- 2 x USB 2.0 (via 10-way header).
- Connector breakout through APOLLO ICE chassis.

## APOLLO-USB-DVO: VGA



The VGA Card converts APOLLO high-resolution DVO (digital video output) to analog CRT outputs, from VGA to SXGA resolutions. The following image shows the VGA card in position:



### *Features*

- VGA output (VGA to SXGA).
- 2 x USB 2.0 (via 10-way header).
- Connector breakout through APOLLO ICE chassis.

## Appendix C – EMC conformity

### EMC

The European Directive 89/336/EEC, on Electro-magnetic Compatibility (EMC), requires that, generated electro-magnetic disturbance must, be in accordance with European Harmonized Standards, for Electro-Magnetic Emissions and Immunity.

### Generic Emissions and Immunity Standards

*Emissions: EN55022:1998, A1, A2*

- Conducted Emissions EN55022, A1, A2 Class B
- Radiated Emissions EN55022, A1, A2 Class B

*Immunity: EN55024:1998, A1, A2*

- Electrostatic Discharge Immunity EN61000-4-2:1995, A1, A2
- Radiated RF Immunity EN61000-4-3:2002
- Transient Immunity EN61000-4-4:2004
- Surges EN61000-4-5:1995, A1
- Conducted Immunity EN61000-4-6:1996, A1
- AC Voltage Dips EN61000-4-11:1994, A1
- Mains Harmonics *EN61000-3-2:2000*

FCC Verification: Part 15B, Class B



This equipment has been tested and found to comply with the limits for a Class B, digital device, pursuant to part 15 of the FCC Rules. These limits are designed to provide reasonable protection against harmful interference when the equipment is operated in a commercial environment. This equipment generates, uses, and can radiate radio frequency energy and, if not installed and used in accordance with the instruction manual, may cause harmful interference to radio communications. Operation of this equipment in a residential area is likely to cause harmful interference in which case the user will be required to correct the interference at their own expense.

# Index

---

## A

ADD card · 10  
 antenna, wireless · 10  
 anti-static · 8  
 audio · 10, 13

---

## B

battery · 8  
   disposal · 8  
   temperature · 8  
 breakout PCB · 27

---

## C

cable plan · 21  
 cards  
   ADD · 10  
   graphics · 33  
   PCI · 10, 23  
 CE/FCC · 6  
 CMOS · 8  
 code, source · 35  
 COM1 · 19  
 COM2 · 19  
 CompactFlash  
   port · 6  
 connectors · 12  
 construction · 20  
 contact details · 32  
 CPU · 5, 6, 7  
 CRT · 7

---

## D

devices, external · 12  
 DRAM · 6  
 drive bay module · 29  
 DVD/CDRW · 6, 10

---

## E

earth stud · 10  
 EMC · 6  
 Ethernet  
   ports · 6, 10  
 external devices · 12

---

## F

fan · 10  
 fan-less systems · 6  
 FDD · 6, 10  
 features · 5, 10  
   optional · 5, 7, 33  
 Firewire · 10, 14, 27, 28  
   port · 6, 10  
 front panel · 10  
   interface · 25

---

## G

graphics cards · 33

---

## H

HDD · 6, 10, 27

---

## I

IEEE1394 · 14  
 interface, front panel · 25  
 internal cables · 21  
 IrDA port · 6

---

## J

J1 · 13  
 J2 · 13  
 J3 · 13  
 J4 · 14  
 J4A · 14  
 J5A · 15  
 J5B · 15  
 J6A · 16  
 J6B · 16  
 J6C · 17  
 J7A · 18  
 J7B · 19  
 J7C · 19

---

## K

keyboard · 10, 16

---

**L****LAN**

- primary · 15
- secondary · 15

LCD · 5, 6, 10, 25

LEDs · 10

LPT1 · 18

---

**M**

module, drive bay · 29

motherboard · 7

mouse · 10, 17

---

**N**

navigation buttons · 5

---

**O**

operating temperature · 6

optional features · 5, 7, 33

---

**P**

packaging · 8

**panel**

- front · 10

- rear · 10

panel, front · 25

parallel port · 6, 10, 18

PCB, breakout · 27

**PCI**

- card · 5, 10, 23

- expansion slots · 6

- module · 23

**ports**

- CompactFlash · 6

- Ethernet · 6, 10

- Firewire · 6, 10

- IrDA · 6

- parallel · 6, 10, 18

- serial · 6, 10, 19

- SPDIF · 6

- USB · 6, 14

**power**

- LED · 10

- supply · 6

- supply unit · 6, 10

primary LAN · 15

processor · 5, 6

PS/2 mouse · 17

---

**R**

rear panel · 10

reset switch · 10, 27

---

**S**

secondary LAN · 15

secure applications · 5

secure systems · 5

serial ports · 6, 10, 19

source code · 32, 35

SPDIF ports · 6

specification · 6

static · 8

support, technical · 32

switch, reset · 10, 27

---

**T**

tamper detection · 5

technical support · 32

temperature · 6

- battery · 8

TPM · 7

trademarks · 2

Trusted Platform Module · 7

---

**U**

USB · 10, 14, 27, 28

- ports · 6

---

**V**

VGA · 10, 16

video · 6, 7

---

**W**

weight · 31

wireless antenna · 10

---